

Automatic flush bolt OLDA 33 HZA-R32F type 1, bolt Ø 12 mm



Function:

Automatic, single action flush bolt for spring-loaded bolting of passive door leaf in double doors.

Features:

OLDA 33 HZA-R32F is bolted and unbolted automatically, has bolt diameter 12 mm, backset 32 mm and forend width 22 mm.

The 60 mm long bolt makes it suitable for integration with automatic drop seals, when there is a large gap between the door leaf and frame or sill and when a sill is not fitted.

Same dimensions as manual flush bolt OLDA 33 HZM-R32.

Usage:

Recessed into door of wood, steel or aluminium profiles, lower left and upper right, at the edge of passive door leaves.

Installation:

Fitted recessed at the edge of the door, either flush with cut-out or without cut-out for the forend. Fixed with two countersunk 4 x 20 mm screws.

Accessories:

Lock tube LT 12 (17x13) and guide tube GT 12 are fastened with two countersunk 3.5 x 16 mm screws. Strike plate SP 20 is fastened with two countersunk 4.2 x 16 mm screws.

Specification:

- Automatic, single action and spring-loaded bolt function
- Bolt:
 - Length: 60 mm
 - diameter: 12 mm
 - projection: 15 mm
 - adjustability: - 7 / + 10 mm
- Round stainless steel forend
- Product:
 - width: 22 mm
 - height: 200 + 82 mm
 - depth: 43 mm
 - forend thickness: 2 mm
- Backset including forend: 34 mm
- Material: steel
- Coating: electrozinc plating

Related products:

- Automatic flush bolts
 - 43 HZA-20T / -32T – 30/60 mm
 - 33 HZA-R32F - Ø 8, 10 & 12 mm
- Manual flush bolts
 - 33 HZM-20 / -32 – 30/60 mm
 - 33 HZM-R32 - Ø 8, 10 & 12 mm

Service:

Function & system tests are recommended once or twice a year. Test, lubricate and adjust moving parts as needed.

In harsh environments or high frequent use should tests be made more often.

Warranty:

All mechanical “OLDA” branded products have a 36-month factory warranty.

Automatic flush bolt OLDA 33 HZA-R32F type 1, bolt Ø 12 mm

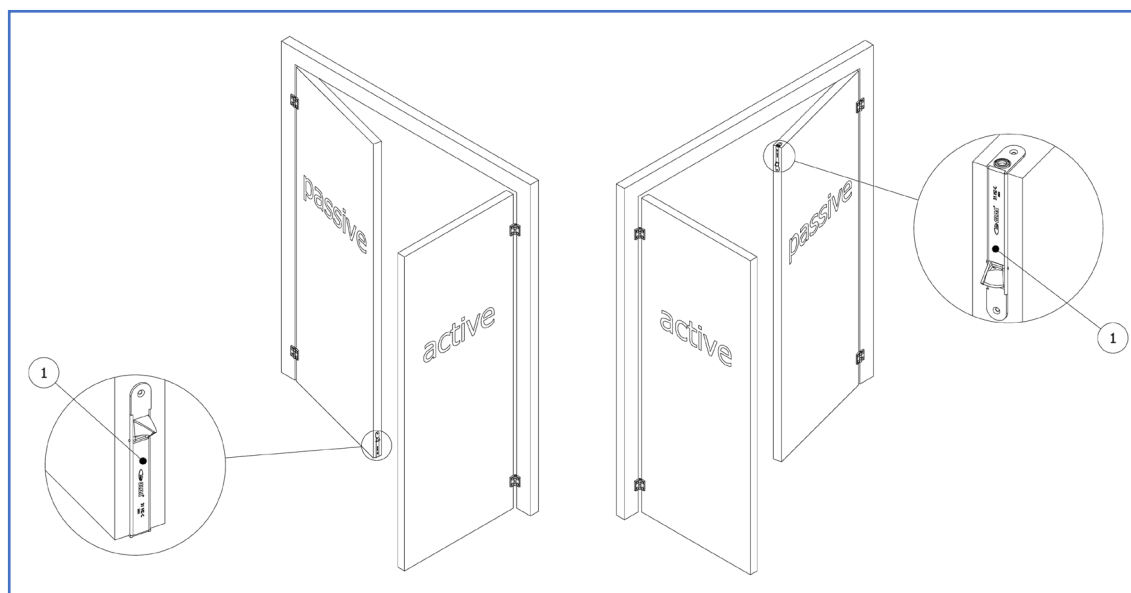
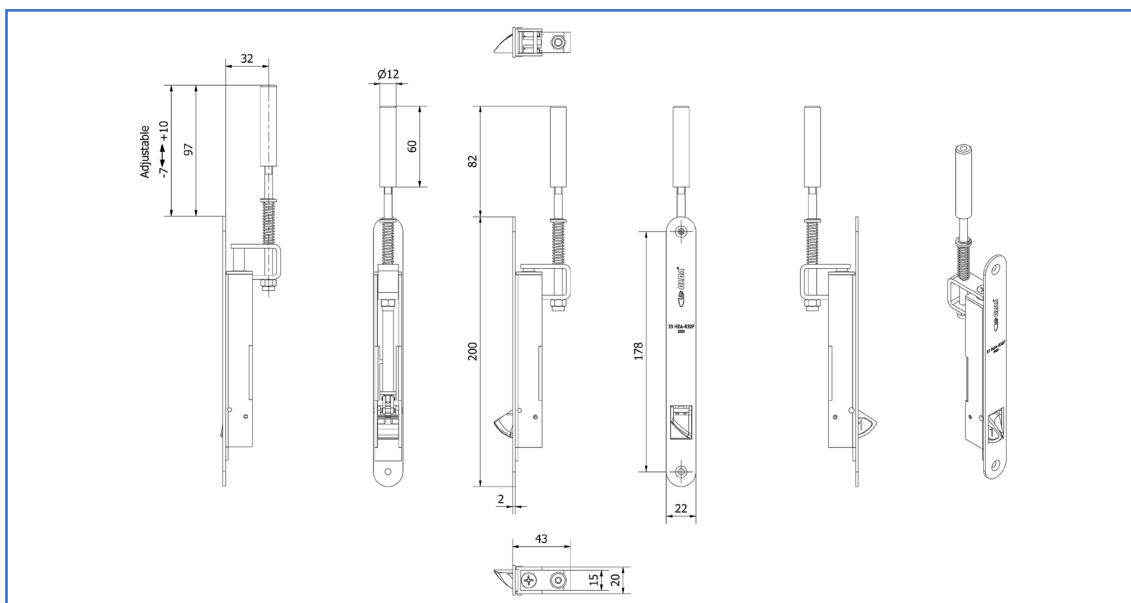

Product documents:

- [Dimensions](#)
- [Installation with forend cut-out](#)
- [Installation without forend cut-out](#)

Product models – 3D:

- [STEP](#)
- [DWG](#)
- [PDF – 3D](#)

Product views – 2D:

- [PDF](#)
- [DXF](#)
- [DWG](#)

OLDA product links:

- [Automatic flush bolt 33 HZA-R32F](#)
- [Manual flush bolt 33 HZM-R32](#)
- [Flush bolt accessories](#)
- [OLDA flush bolt guide](#)
- [OLDA fittings school](#)