

## Manual flush bolt OLDA 30 HZM, extended bolt +30 mm



### Function:

Manual, single action flush bolt for non-spring-loaded bolting of passive door leaf in double doors.

### Features:

OLDA 30 HZM is bolted with a lever mechanism and has bolt diameter 10 mm, backset 12 mm and forend width 25 mm.

Same dimensions as automatic flush bolts OLDA 28 HZA type 1 and type 2.

### Usage:

To be recessed into wooden doors, both upper and/or lower, at the edge of passive door leaves.

### Installation:

OLDA 30 HZM is fitted recessed in the edge of the door, either flush with cut-out or without cut-out for the forend. Fixed with four countersunk 3.5 x 40 mm screws.

### Accessories:

Lock plate LP 10 is fastened with four countersunk 3.5 x 16 mm screws.

### Specification:

- Manual, single action and non-spring-loaded bolt function
- Bolt:
  - diameter: 10 mm
  - projection: 49 mm
  - adjustability: -0 / +7 mm
- Round electrozinc plated steel forend
- Product:
  - width: 25 mm
  - height: 168 + 30 mm
  - depth: 20 mm
  - forend thickness: 2 mm
- Backset including forend: 12 mm
- Material: steel
- Coating: electrozinc plating

### Related products, forend width 25 mm:

- Versions with extended bolts
  - 30 HZM
    - +8, +15, +20 and +30 mm
  - 28 HZA type 1
    - +8, +15, +20 and +30 mm
  - 28 HZA type 2
    - +8, +15, +20 and +30 mm
- Manual flush bolt
  - 30 HZM
- Automatic flush bolts
  - 28 HZA type 1
  - 28 HZA type 2

### Service:

Function & system tests are recommended once or twice a year. Test, lubricate and adjust moving parts as needed.

In harsh environments or high frequent use should tests be made more often.

### Warranty:

All mechanical "OLDA" branded products have a 36-month factory warranty.

**Manual flush bolt OLDA 30 HZM, extended bolt +30 mm**

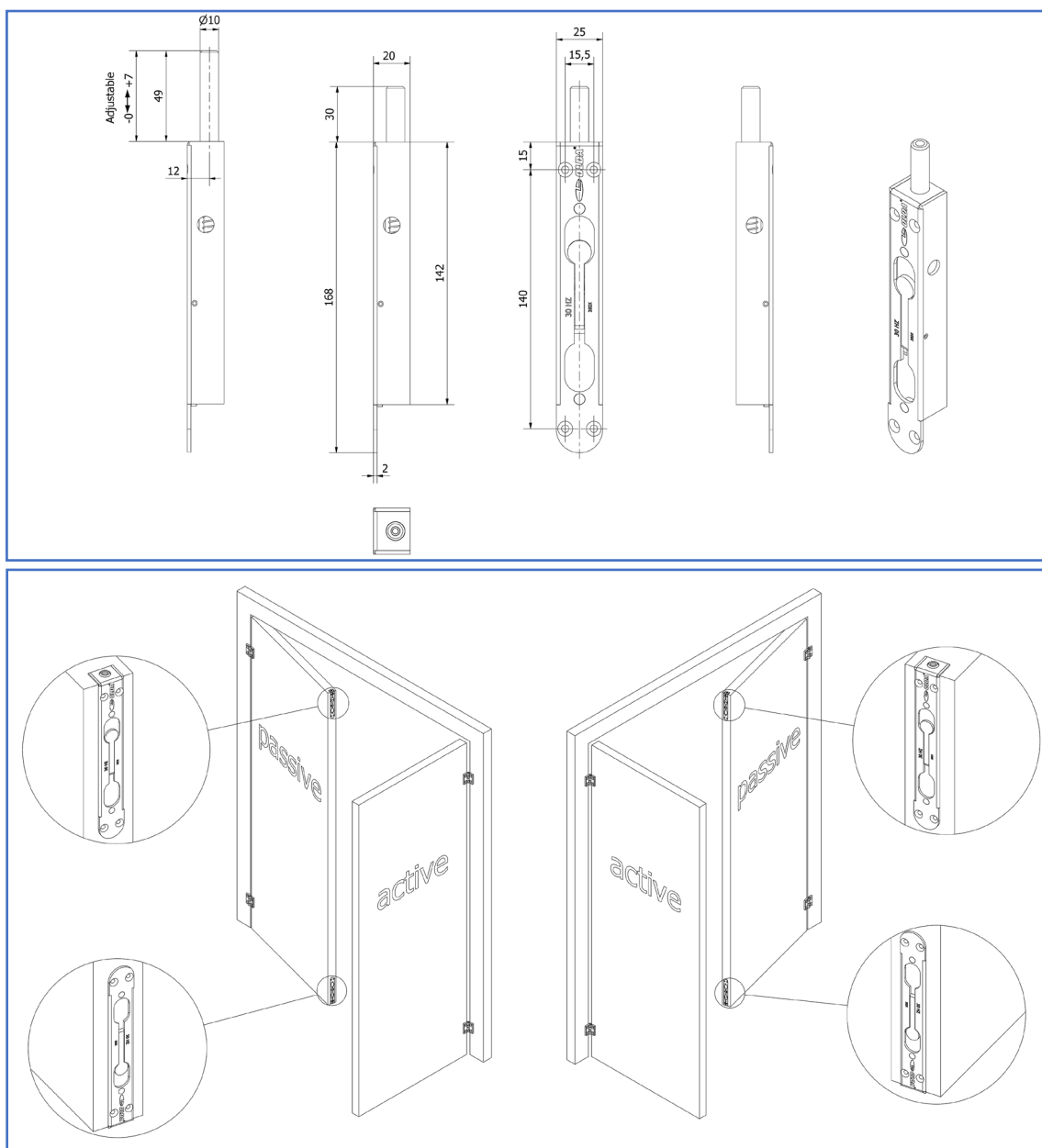

**Product documents:**

- [Dimensions](#)
- [Installation with forend cut-out](#)

**Product views – 2D:**

- [PDF](#)
- [DXF](#)
- [DWG](#)

**Product models – 3D:**

- [STEP](#)
- [PDF – 3D](#)

**OLDA product links:**

- [Manual flush bolt 30 HZM, extended bolts](#)
- [Automatic flush bolts 28 HZA, extended bolts](#)
- [Flush bolt accessories](#)
- [OLDA flush bolt guide](#)
- [OLDA fittings school](#)