

Lock tube OLDA LT 12 (13x17)



Function:

A lock tube is used together with flush bolts with round bolt, to ensure a secure bolting, especially in connection with prolonged bolts and/or long rods.

Lock tubes optimize the function of flush bolts by reducing the friction between bolt and its entry hole in frame or sill.

Features:

Lock tube OLDA LT is 20 mm deep and 22 mm wide with oval holes. LT 12 (13x17) has width 13 and height 17 mm, intended for bolt \varnothing 12 mm. An oval hole in the opposite direction is available as OLDA LT 12 (17x13).

Made in electrozinc plated zinc.

Usage:

OLDA LT lock tubes are recommended to secure the function and increase lifespan of flush bolts, typically recessed in frame or sill made of wood, steel- or aluminium.

LT guide tubes are often used together with OLDA GT guide tubes with round holes in the door leaf.

The oval hole allows for extra movement if the door leaf “hangs” over the years.

If a more precise lock tube with a circular hole is required, an OLDA GT can be used instead, since its hole is also countersunk.

Combining lock and guide tubes are especially important if the door leaf is equipped automatic drop seals.

Installation:

OLDA LT is usually fitted along the frame or sill with the largest width of the oval hole i.e., LT 12 (17x13). At a minimum depth of 60 mm in the frame or sill, lock tubes can be orientated in the opening direction of the door using the largest height of the oval hole i.e., LT 12 (13x17).

OLDA LT are fitted with two countersunk 3.5 x 16 mm screws, either with 2 mm visible height or fully recessed due to the round corners.

Specification:

- Outer diameter: 22 mm
- Height: 20 mm
- Hole (width x height): 13 x 17 mm
- Forend: 53x22x2 mm
- Thickness: 2 mm
- Material: zinc
- Coating: electrozinc plating

Related products:

- Strike plates; SP 10, 10-T & 20
- Lock plates; LP 10, 20 & 30
- Lock tubes; LT 8, 10, 12 & 14
- Guide tubes; GT 8, 10, 12 & 14

Service:

Function & system tests are recommended once or twice a year. Test and clean moving parts as needed.

In harsh environments or high frequent use should tests be made more often.

Warranty:

All mechanical “OLDA” branded products have a 36-month factory warranty.

Lock tube OLDA LT 12 (13x17)

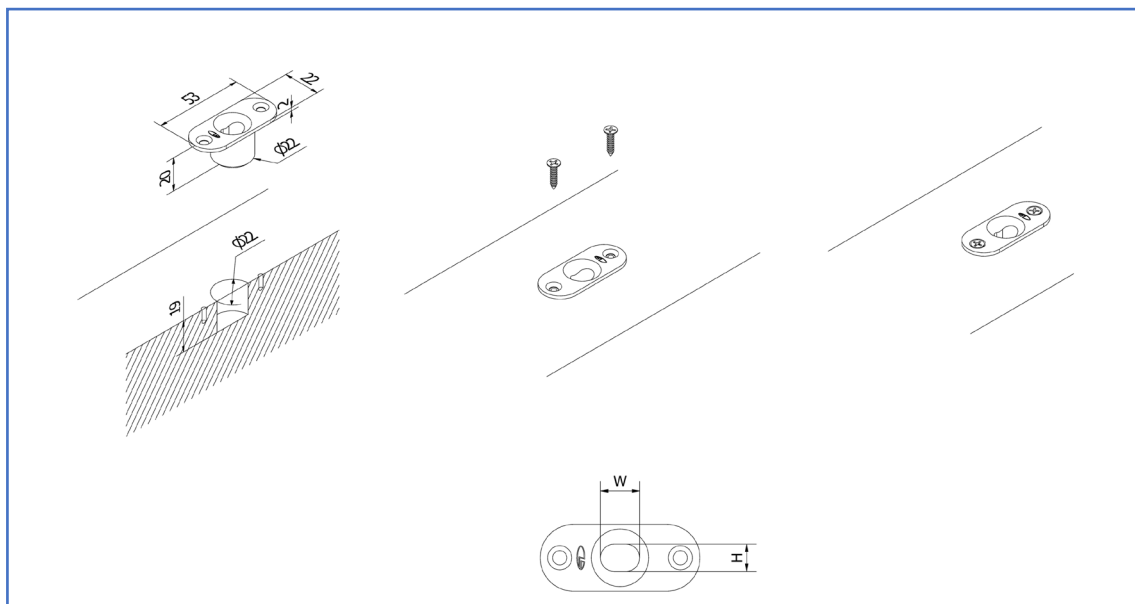
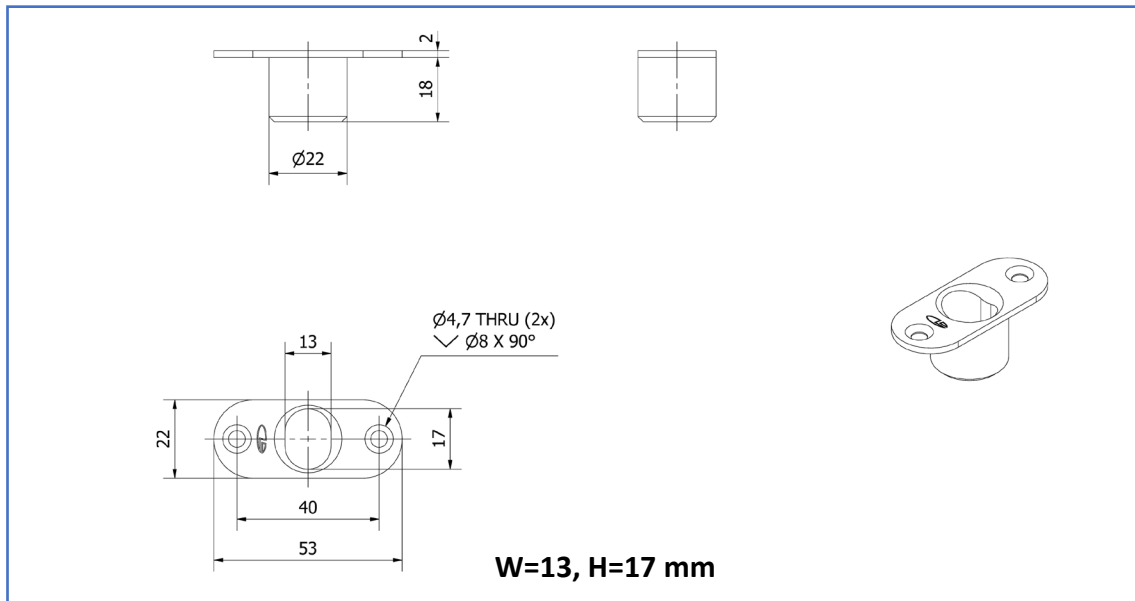

Product documents:

- [Dimensions](#)
- [Installation](#)

Product views – 2D:

- [PDF](#)
- [DXF](#)
- [DWG](#)

Product models – 3D:

- [STEP](#)
- [DWG](#)
- [PDF – 3D](#)

OLDA product links:

- [Lock tubes OLDA LT](#)
- [Flush bolt accessories](#)
- [OLDA flush bolts](#)
- [OLDA fittings school](#)