

## Guide Tube OLDA GT 14



### Function:

A guide tube is used together with flush bolts with round bolt, to ensure a secure bolting, especially in connection with prolonged bolts and/or long rods.

Guide tubes optimize the function of flush bolts by reducing the friction between bolt and its exit hole in the door leaf.

### Features:

Guide tube OLDA GT is 20 mm deep and 22 mm wide with circular holes. GT 14 has a  $\varnothing$  14.5 mm hole intended for bolt diameter 14 mm.

Made in electrozinc plated zinc.

### Usage:

OLDA GT guide tubes are recommended to secure the function and prolong the lifespan of flush bolts, and are recessed in doors made of wood, steel- or aluminium.

GT guide tubes are often used together with OLDA LT lock tubes with oval holes, in frame or sill, allowing for extra movement if the door leaf “hangs” over the years.

The combination of guide and lock tubes are especially important if the door leaf has automatic drop seals.

If a more precise lock tube with a circular hole is required, an OLDA GT can be used instead, since its hole is also countersunk.

### Installation:

OLDA GT 14 is fitted in the top / bottom of the door leaf edge. When fitted externally, visible height is only 2 mm. The round corners facilitate fully recessed fitting. It is fastened with two countersunk 3.5 x 16 mm screws.

### Specification:

- Outer diameter: 22 mm
- Height: 20 mm
- Hole diameter: 14.5 mm
- Forend: 53x22x2 mm
- Thickness: 2 mm
- Material: zinc
- Coating: electrozinc plating

### Related products:

- Strike plates
  - SP 10, 10-T & 20
- Lock plates
  - LP 10, 20 & 30
- Lock tubes
  - LT 8, 10, 12 & 14
- Guide tubes
  - GT 8, 10, 12 & 14

### Service:

Function & system tests are recommended once or twice a year. Test and clean moving parts as needed.

In harsh environments or high frequent use should tests be made more often.

### Warranty:

All mechanical “OLDA” branded products have a 36-month factory warranty.

## Guide tube OLDA GT 14

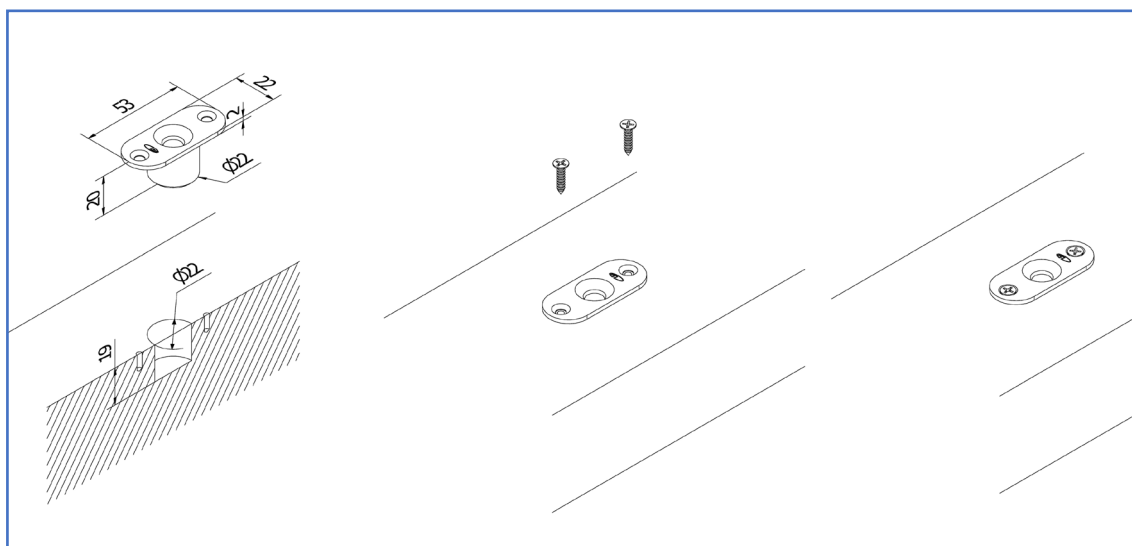
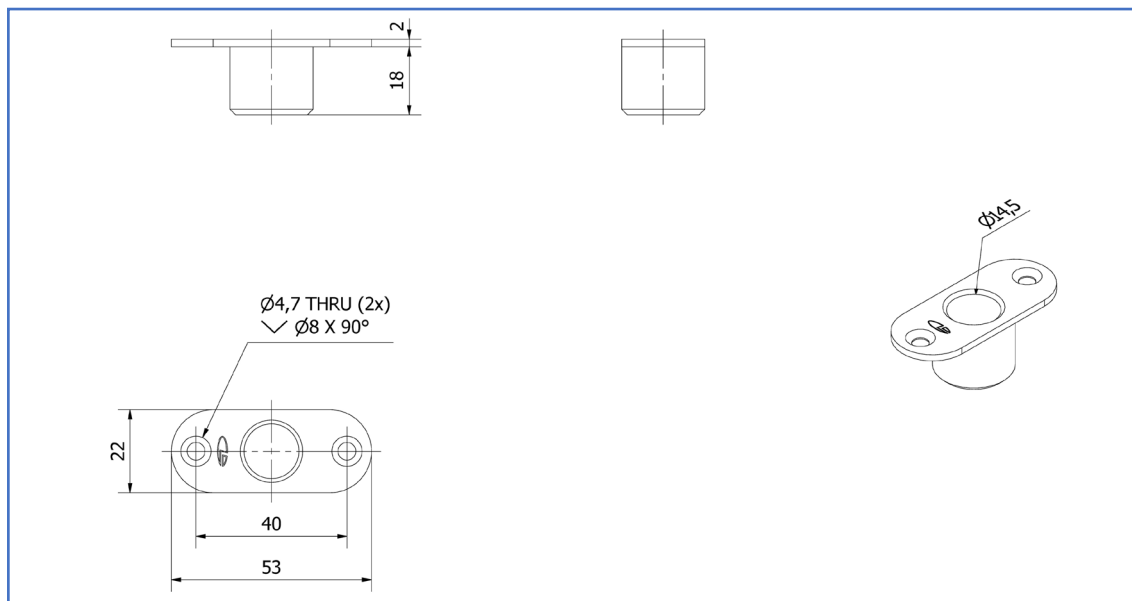

### Product documents:

- [Dimensions](#)
- [Installation](#)

### Product views – 2D:

- [PDF](#)
- [DXF](#)
- [DWG](#)

### Product models – 3D:

- [STEP](#)
- [DWG](#)
- [PDF – 3D](#)

### OLDA product links:

- [Guide tubes OLDA GT](#)
- [Flush bolt accessories](#)
- [OLDA flush bolts](#)
- [OLDA fittings school](#)