

Double action manual flush bolt OLDA 511 HZM-20



Product-ID: 11-511-0004-1201

GTIN: 7340171407974

Function:

Manual, double action flush bolt for non-spring-loaded bolting of passive door leaf in double doors, windows and doors.

Features:

OLDA 511 HZM-20 is bolted and unbolted with a handle rotated 90° in the □ 8 mm hole. Stainless forend 20x225 mm, backset 20 mm and two M10 couplings.

Usage:

Recessed into the edge of doors leaves and windows made of wood, steel or aluminium. Enables a hidden "espagnolette function" in doors/windows with optional handle.

Installation:

Fitted recessed in the edge of the door/window edge, with/without forend cut-out. Fixed with two countersunk 4,2 x 25 mm screws.

The handle is mounted on one/two sides depending on desired level of security.

M10 adapters to M8- & M6 threaded rods are available.

The chosen threaded rod is cut to length, connected top and/or bottom depending on the needs of the current application.

Accessories:

OLDA bolt Ø 12x60 mm (art #18-020-1203-3001), guide tube GT 12 together with lock tube LT 12 (17x13) fits M6 threaded rod.

Specification:

- Manuell, double action and non-spring-loaded bolt function
- Projection: 12 mm
- Round forend of stainless steel
- Product:
 - width: 20 mm
 - height: 225 mm
 - depth: 38,5 mm
 - forend thickness: 3 mm
- Backset including forend: 23 mm
- Fits handle: □ 8 mm
- Material: steel
- Coating: electro zinc plating

Related products:

Manuella flush bolt 511 HZM also available with backset 32 & 43 mm.

Product guides:

[OLDA flush bolts](#)

[OLDA accessories](#)

Service:

Function-/system tests are recommended once or twice a year. Lubricate and adjust as needed, and test more often in harsh environments.

Warranty:

All mechanical "OLDA" branded products have a 36-month factory warranty.

Environment and quality:

RZ Olda Innovation AB works continuously with the improvement of our products' [environmental](#)- & quality performance, and are [ISO 9001 & 14001](#) certified.

Double action manual flush bolt OLDA 511 HZM-20

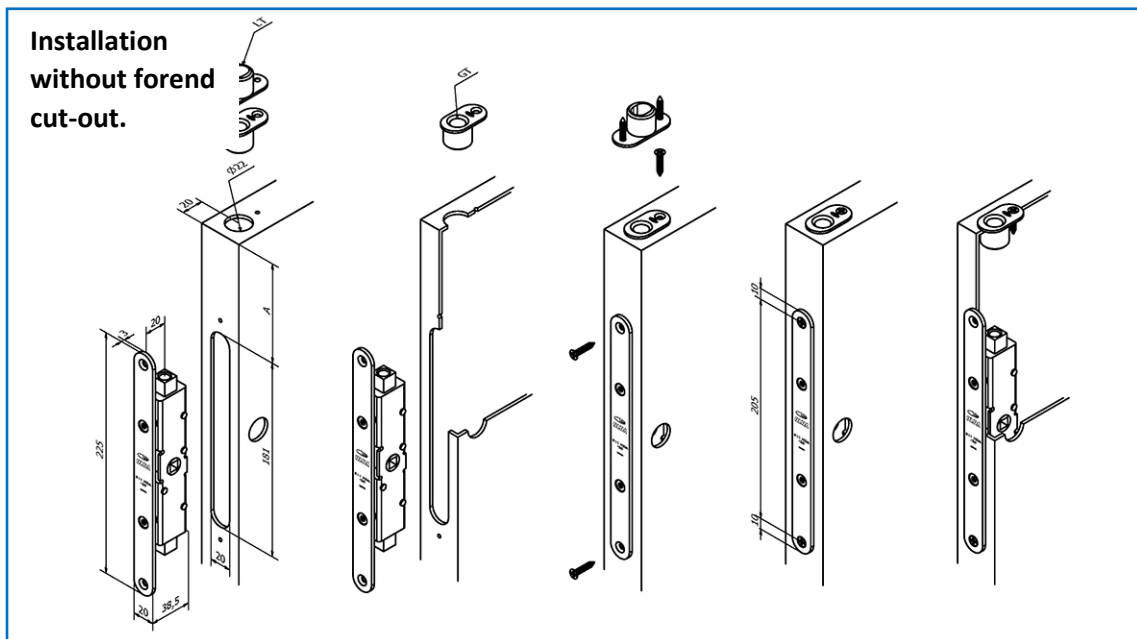
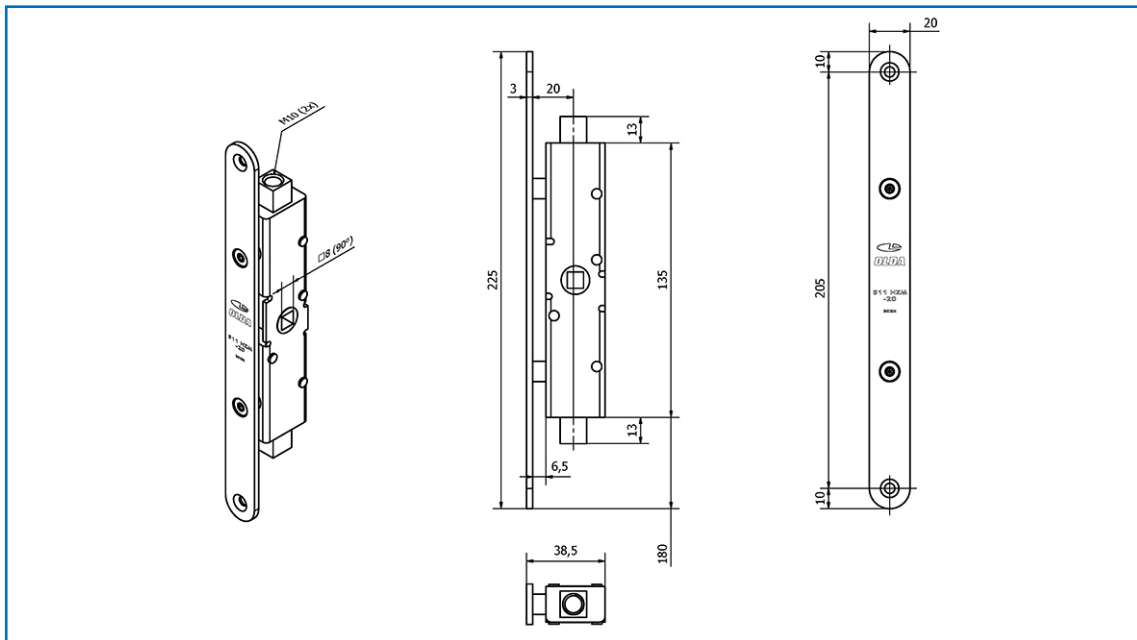

Product documents:

- [Dimensions](#)
- [Installation – with forend cut-out](#)
- [Installation – without forend cut-out](#)

Product models – 3D:

- [STEP](#)
- [DWG](#)
- [PDF – 3D](#)

Product views – 2D:

- [PDF](#)
- [DXF](#)
- [DWG](#)

OLDA 511 HZM-32 schematics:

- [511 kit - rendering](#)
- [511 kit – assembly drawing](#)
- [511 kit – exploded view](#)