

Automatic flush bolt OLDA 33 HZA-R32F type 1, bolt Ø 8 mm



Function:

Automatic, single action flush bolt for spring-loaded bolting of passive door leaf in double doors.

Features:

OLDA 33 HZA-R32F is bolted and unbolted automatically, has bolt diameter 8 mm, backset 32 mm and forend width 22 mm.

The 60 mm long bolt makes it suitable for integration with automatic drop seals, when there is a large gap between the door leaf and frame or sill and when a sill is not fitted.

Same dimensions as manual flush bolt OLDA 33 HZM-R32.

Usage:

Recessed into door of wood, steel or aluminium profiles, lower left and upper right, at the edge of passive door leaves.

Installation:

Fitted recessed at the edge of the door, either flush with cut-out or without cut-out for the forend. Fixed with two countersunk 4 x 20 mm screws.

Accessories:

Lock tube LT 8 (13x9) and guide tube GT 8 are fastened with two countersunk 3.5 x 16 mm screws. Strike plate SP 20 is fastened with two countersunk 4.2 x 16 mm screws.

Specification:

- Automatic, single action and spring-loaded bolt function
- Bolt:
 - Length: 60 mm
 - diameter: 8 mm
 - projection: 15 mm
 - adjustability: - 7 / + 10 mm
- Round stainless steel forend
- Product:
 - width: 22 mm
 - height: 200 + 82 mm
 - depth: 43 mm
 - forend thickness: 2 mm
- Backset including forend: 34 mm
- Material: steel
- Coating: electrozinc plating

Related products:

- Automatic flush bolts
 - 43 HZA-20T / -32T – 30/60 mm
 - 33 HZA-R32F - Ø 8, 10 & 12 mm
- Manual flush bolts
 - 33 HZM-20 / -32 – 30/60 mm
 - 33 HZM-R32 - Ø 8, 10 & 12 mm

Service:

Function & system tests are recommended once or twice a year. Test, lubricate and adjust moving parts as needed.

In harsh environments or high frequent use should tests be made more often.

Warranty:

All mechanical “OLDA” branded products have a 36-month factory warranty.

Automatic flush bolt OLDA 33 HZA-R32F type 1, bolt Ø 8 mm

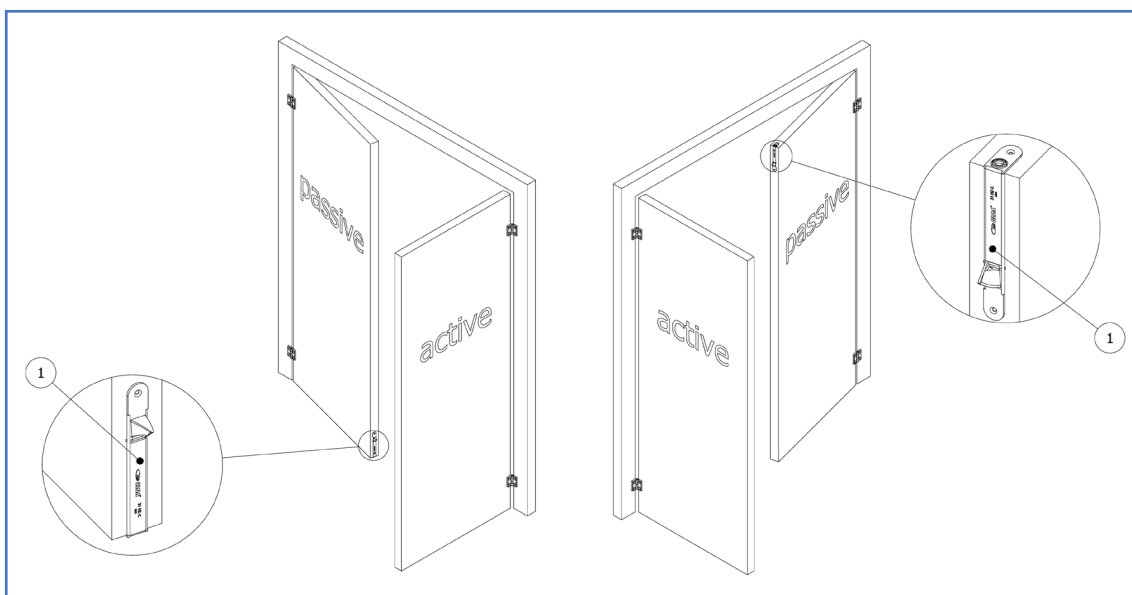
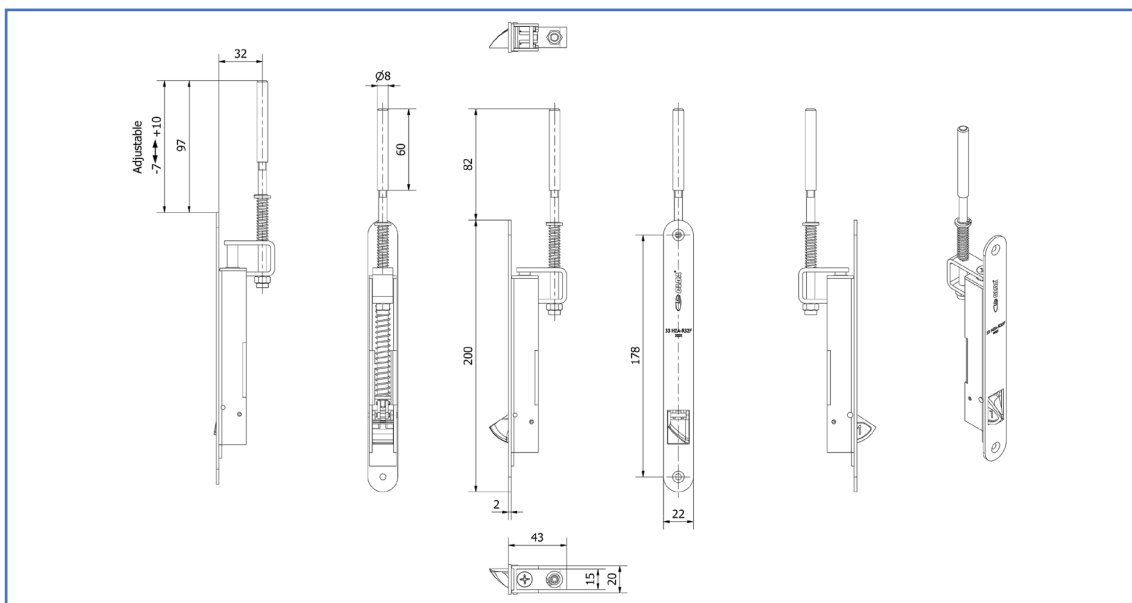

Product documents:

- [Dimensions](#)
- [Installation with forend cut-out](#)
- [Installation without forend cut-out](#)

Product models – 3D:

- [STEP](#)
- [DWG](#)
- [PDF – 3D](#)

Product views – 2D:

- [PDF](#)
- [DXF](#)
- [DWG](#)

OLDA product links:

- [Automatic flush bolt 33 HZA-R32F](#)
- [Manual flush bolt 33 HZM-R32](#)
- [Flush bolt accessories](#)
- [OLDA flush bolt guide](#)
- [OLDA fittings school](#)