

**OLDA 28 HZA - type 2 - automatic flush bolt - extended bolt +30 mm**

view - drawing

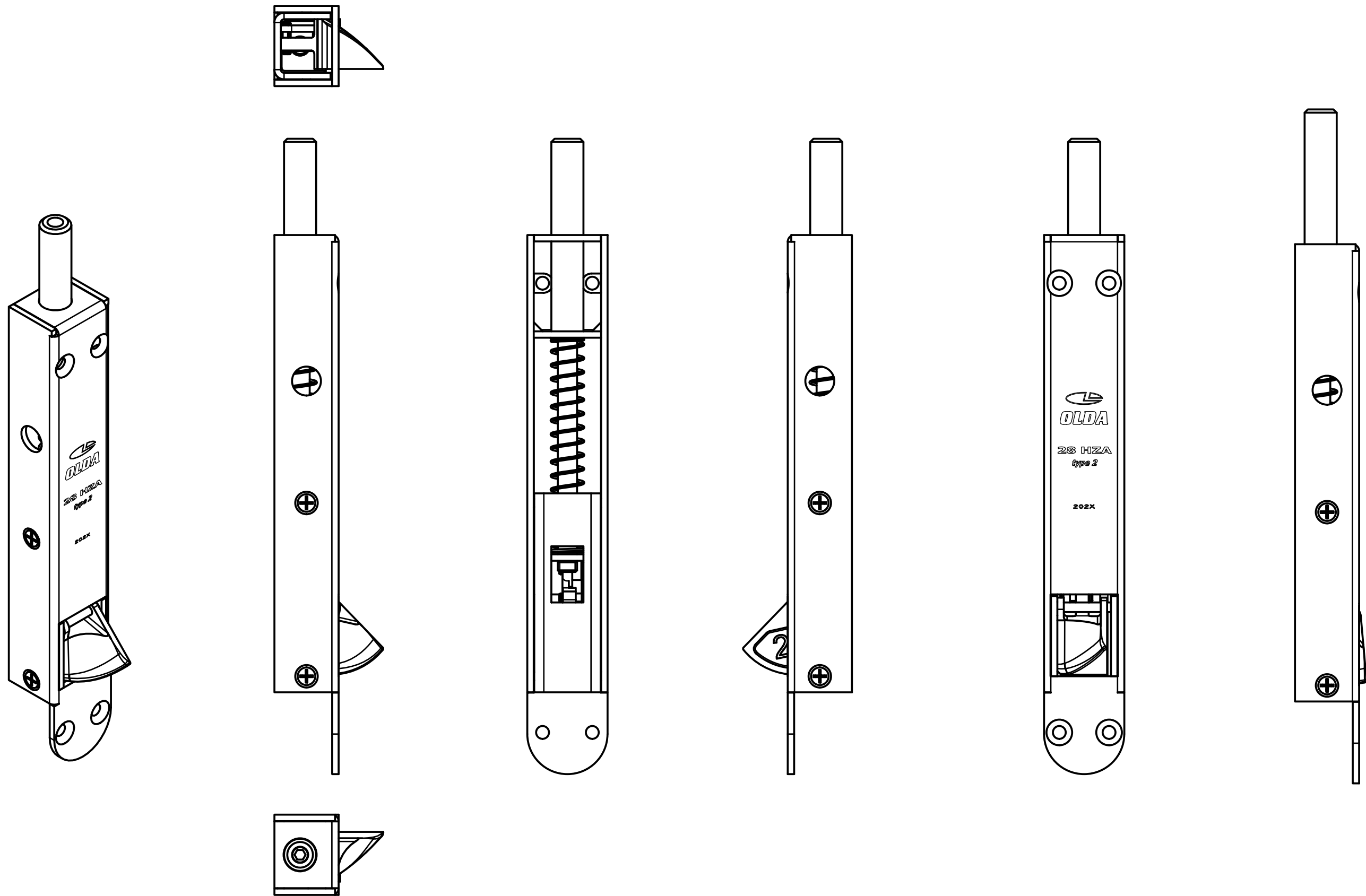

10-128-2002	C	2023-10-30
-------------	---	------------