

OLDA 28 HZA - type 1 - automatic flush bolt - extended bolt +8 mm

dimension - drawing

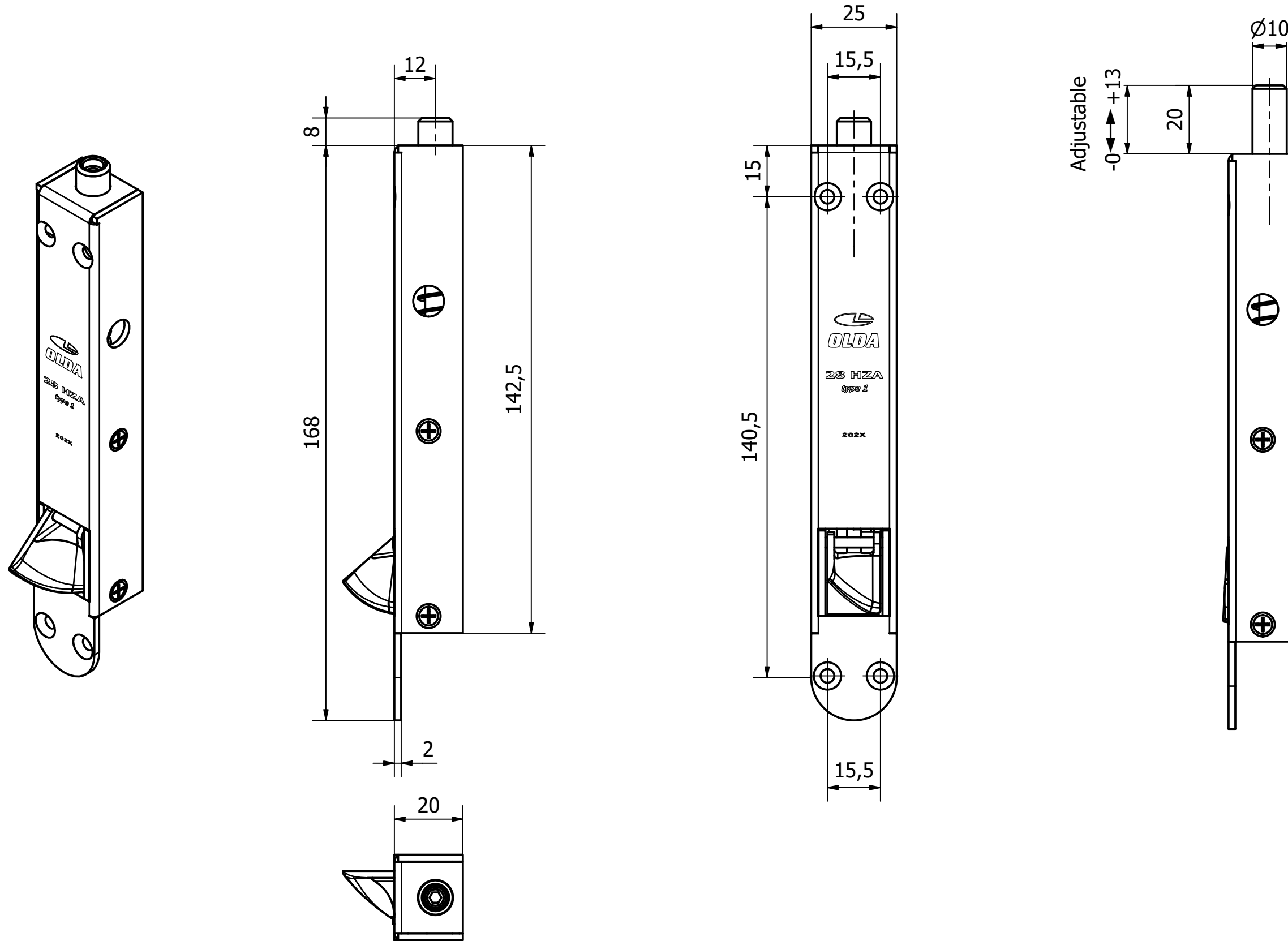

10-128-1003	C	2023-10-31
-------------	---	------------