

OLDA 28 HZA - type 1 - automatic flush bolt - extended bolt +20 mm

dimension - drawing

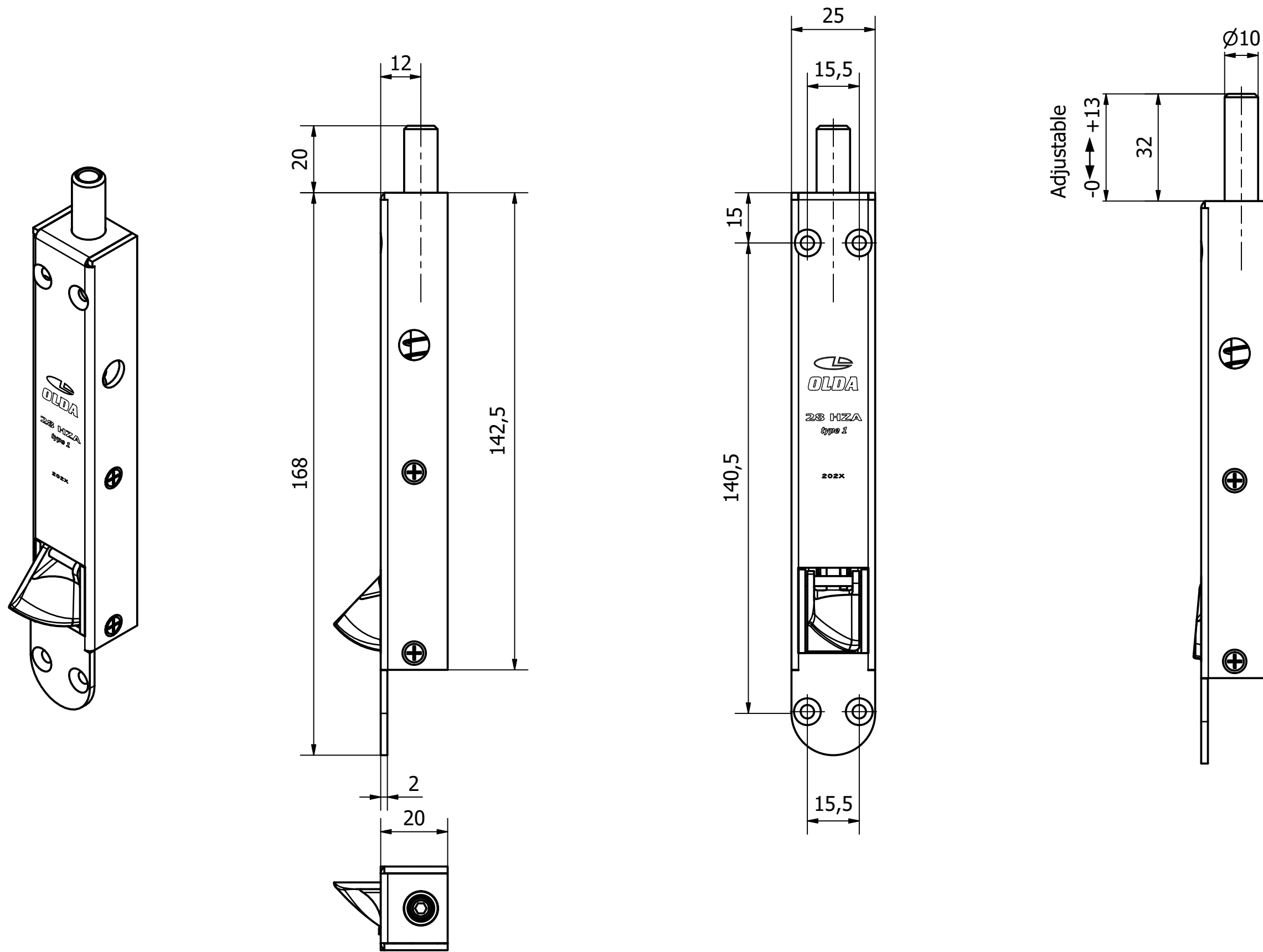

10-128-1004	C	2023-11-01
-------------	---	------------