

Automatic flush bolt OLDA 28 HZA type 2, extended bolt +8 mm



Function:

Automatic, single action flush bolt for non-spring-loaded bolting of passive door leaf in double doors.

Features:

OLDA 28 HZA is bolted and unbolted automatically, and has bolt diameter 10 mm, backset 12 mm and forend width 25 mm.

Same dimensions as manual flush bolt OLDA 30 HZM.

Usage:

To be recessed into wooden doors, upper left and lower right, at the edge of passive door leaves.

Installation:

OLDA 28 HZ is fitted recessed in the edge of the door, either flush, with cut-out or without cut-out for the forend. Fixed with four countersunk 3.5 x 40 mm screws.

Accessories:

Lock plate LP 10 is fastened with four countersunk 3.5 x 16 mm screws.
Strike plate SP 10 is fastened with three 1 x 15 mm nails.

Specification:

- Automatic, single action and non-spring-loaded bolt function
- Bolt:
 - diameter: 10 mm
 - projection: 20 mm
 - adjustability: - 0 / + 13 mm
- Round electrozinc plated steel forend
- Product:
 - width: 25 mm
 - height: 168 +8 mm
 - depth: 20 mm
 - forend thickness: 2 mm
- Backset including forend: 12 mm
- Material: steel
- Coating: electrozinc plating

Related products, forend width 25 mm:

- Versions with extended bolts
 - 28 HZA type 1
 - +8, +15, +20 and +30 mm
 - 28 HZA type 2
 - +8, +15, +20 and +30 mm
 - 30 HZM
 - +8, +15, +20 and +30 mm
- Automatic flush bolts
 - 28 HZA type 1
 - 28 HZA type 2
- Manual flush bolt
 - 30 HZM

Service:

Function & system tests are recommended once or twice a year. Test, lubricate and adjust moving parts as needed.

In harsh environments or high frequent use should tests be made more often.

Warranty:

All mechanical "OLDA" branded products have a 36-month factory warranty.

Automatic flush bolt OLDA 28 HZA type 2, extended bolt +8 mm

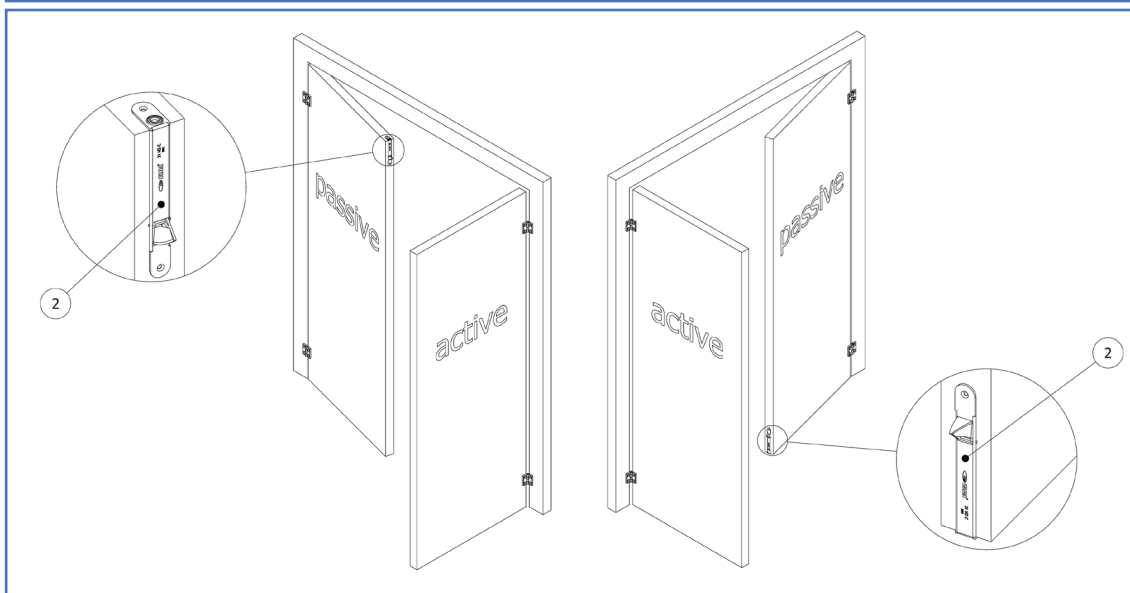
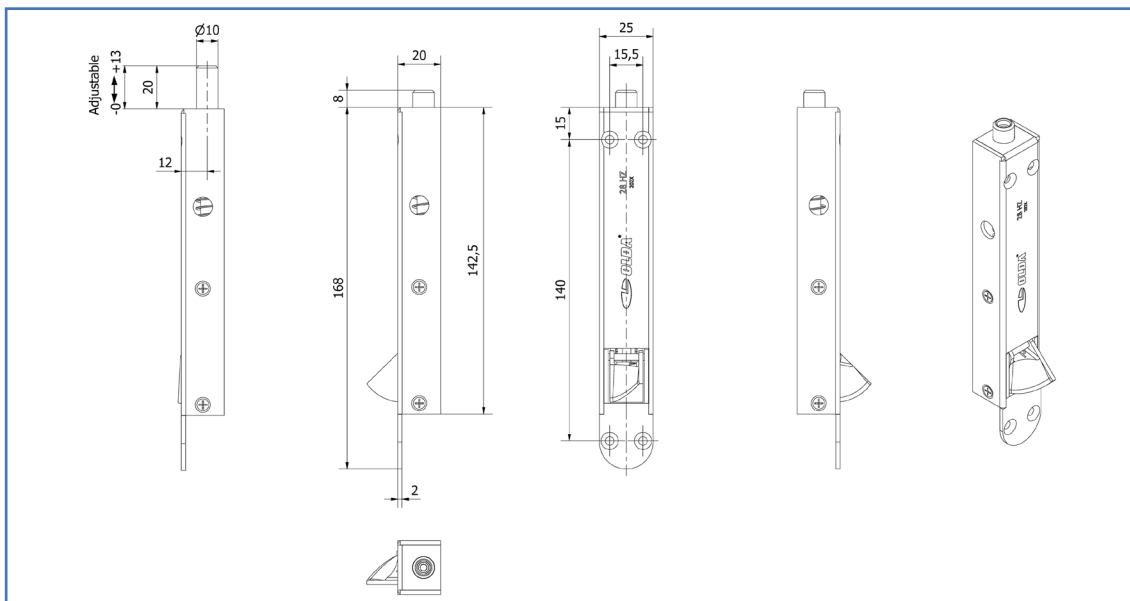

Product documents:

- [Dimensions](#)
- [Installation with forend cut-out](#)

Product views – 2D:

- [PDF](#)
- [DXF](#)
- [DWG](#)

Product models – 3D:

- [STEP](#)
- [PDF – 3D](#)

OLDA product links:

- [Automatic flush bolt 28 HZA, extended bolts](#)
- [Manual flush bolt 30 HZM, extended bolts](#)
- [Flush bolt accessories](#)
- [OLDA flush bolt guide](#)
- [OLDA fittings school](#)